

Hager Ltd.

Unit M2

Furry Park Industrial Estate

Santry

Dublin D09 NY19

Republic of Ireland Tel: 1890 551 502

Northern Ireland Tel: 00 44 7968 147444



KLCM Sensing Options

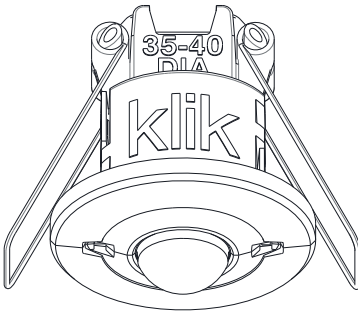

ZD0782_IE

Sensor Control (Standard, Corridor, Large Area)

Using one of the KLCM range of sensors allows maximum energy savings to be achieved whilst retaining the required amount of lighting when occupation is detected. Connect to the LCM using the RJ11 lead supplied

KLCM-OS

Single head SELV Sensor, these can be used for all applications and come with a 10m RJ11 Lead. If used for a corridor application ensure sensors are spaced equally and cover all doors on to the corridor.

KLCM-3OS

3 Head SELV Sensors for use in corridors or narrow rooms, sensor heads should be orientated along the corridor.

KLCM-5OS

5 Head SELV Sensors give more wide area coverage of approx 15m².

Other Hager Sensors are available for both special applications or for part of a standard Klik or other lighting control installation. Please see the latest catalogue on www.hager.ie



To configure in the App, Select "Channel" then "Absence/presence" and "Input Mapping" to allocate to a Channel.

KLCM-OS

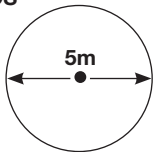

KLCM-3OS

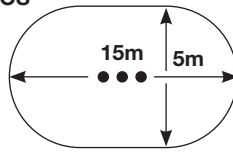

KLCM-5OS

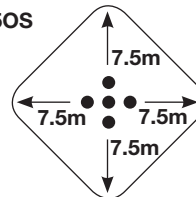

Daylight Dimming including Sensor Offset

This configuration will provide a constant regulated light level which is monitored by the digital lux sensor integrated within the KLCM-OS range of sensors.

The sensor should be positioned within the area to be controlled mid-way between lights for best performance. Connect into a sensor input using the RJ11 lead supplied.

This technique can also be used to regulate lights when natural light does not exist to allow for over lighting when new and under lighting as lamps age. This can be of particular use where LED lights are installed that may be prone to light output degradation.



To configure in the App, Select "Input Mapping" to allocate the sensor followed by "Sync". A sensor can be mapped to multiple outputs and also to different levels.



Do not activate "Daylight Dimming" during this process. Once desired level is achieved, switch on "Daylight Dimming" and "Sync".

Absence & Presence

The most common scenarios we see our customers use are based on Presence Detection (People entering an area and moving around switches lights on) or Absence Detection (Manual switch on and then switches off when no movement detected). Connecting switches and occupancy sensors to the LCM will be the same be it is absence or presence. (Please see schematic on page 2).



To configure in the App, Select the required channel i.e. channel A and select the PIR function as required, here you can also set the required time-out and staged time-out to dim level.

Input Mapping is used to associate the required Sensors and Switches to the outputs.

ZD0782_IE



Hager Ltd.

Unit M2

Furry Park Industrial Estate

Santry

Dublin D09 NY19

Republic of Ireland Tel: 1890 551 502

Northern Ireland Tel: 00 44 7968 147444

Hager RJ45 Pin Out

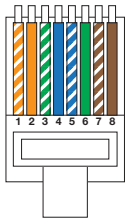

- 1. White Orange
- 2. Orange
- 3. White Green
- 4. Blue
- 5. White Blue
- 6. Green
- 7. White Brown
- 8. Brown

KLCM Switching Options

Partition Switching

Partition Switch functionality provides the facility to accommodate a removable partition switch and remap the light switches accordingly. This is achieved using Profiles 1 & 2.

Wire the partition switch as below and plug in to Switch Input 1 ONLY. When switch is open, Profile 1 is active, switch closed, Profile 2 Active.

To configure in the app, select 'global settings' and then 'Partition Switch Enable'

Scene Setting

Scene setting allows for up to four scenes which can utilise all four outputs. Scenes are created in the Kliklink App. Standard volt free connections are available at the switch inputs allowing any suitable volt free switch to be used.

All four of the switch inputs can be used for Scene switch inputs. They are all connected in Parallel internally. An On/Off switch will be required to switch off in this instance as time out function will be inoperative. Please see the Sollysta Wiring Accessory Range, White, Decorative and Part M available for use with Klik. A dedicated scene plate is also available, please call for further information.

To configure the app, select 'Scene Setting'.

Classroom Control

Classrooms tend to have specific requirements where lights are controlled by absence detection and also daylight dimming. Override switches are often used for whiteboard and screens.

The Absence Switch and Board/Screen switches are wired the same using separate switch inputs. The switches have to be wired as shown above and connected to the Switch inputs configured in the Kliklink App. Switches must be two way retractive.

To configure in the App, Select "Input Mapping" and then select the switch input used (1-4) on the channel required (A-D), then "Sync"

KLO*RJ45G RJ45 Switch Drop (plug-to-plug), Grey

KLO*RJ45R RJ45 Link lead (plug-to-plug), Red

KLORJ45CON RJ45 Splitter

*5, 10, 15, 20, 30, 40, 50

Hager strongly recommends the use of Hager supplied RJ54 cables for all installations. All Hager leads are tested prior to shipment. If other manufacturers RJ45 cables are used we recommend that each lead is tested with a dedicated RJ45 tester prior to installation. Should Hager be called to site to support the installation and a fault is found with the RJ45 cables, then a charge for site support will be incurred.

Hager Pre-Installed Scenarios - KlikLink for iPad

The above are a selection of scenarios that typical of those used by our customers. To make things even easier we have already saved a number of scenarios in the App. These may be perfect for your installation or act as a starting point that you can modify to suit and then save and call your own.

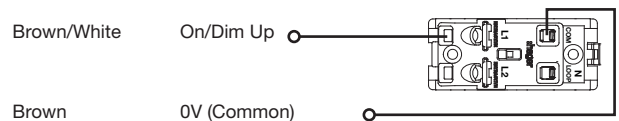

WMGS12 - 20A, 2 way grid switch - white

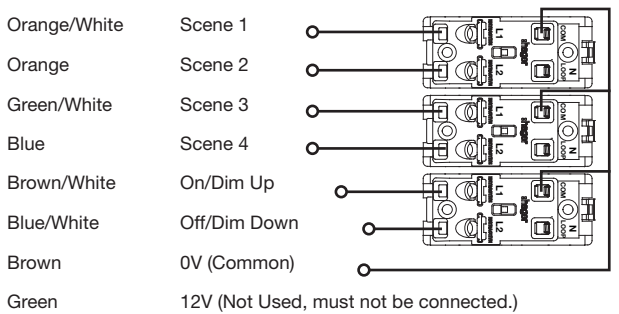

WMGS13R - 20A, 2 way, centre off, retractive grid switch - white

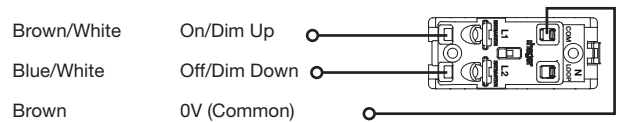

WMGS13R - 20A, 2 way, centre off retractive grid switch - white

ZD0782_IE

ZD0782_IE